

版本号		密级	内部		
A0		阶段 标记			S
会签	<u>RFL-P70MX</u>				
谢良	<u>70MX 激光器英文说明书</u>				
夏巨江					
刘红	<u>RFL-P70MX · JS03</u>				
帅维文					
	部 门 <u>脉冲激光器技术研究部</u>				
	编 写 <u>胡晓蕾 20210315</u>				
	校 对 <u>李 莎 20210316</u>				
	审 核 <u>李 科 20210322</u>				
	标 审 <u>李其军 20210322</u>				
	批 准 <u>黄 保 20210322</u>				
旧底图登记号	武汉锐科光纤激光技术股份有限公司				
/					
底图登记号					
/					

User Instruction

RFL-P70MX

Wuhan Raycus Fiber Laser Technologies CO., Ltd.

2021

Safety Information

Please read this instruction carefully and familiarize yourself with the information we have provided before you use the product. In this brochure, important operation procedures, safety and other information are provided for you and all future users. In order to ensure operating safely and optimal performance of the product, please act according to following warnings, cautions and other information.

- a) Raycus pulsed fiber laser is classified as a high power Class IV laser device. Before supplying the power to the device, please make sure that the correct voltage of 24V DC is connected and the anode and cathode are right. Incorrect polarity or voltage will harm severely the device.
- b) The device emits invisible light with a wavelength from $\lambda = 1060\text{nm}$ to $\lambda = 1085\text{nm}$ with average power of 70W. Do not expose your eyes or skin to the radiation of the laser.
- c) Do not take apart the device, because there are no replaceable accessories available for users to use. Any maintenance can only be proceeded in Raycus.
- d) Do not look into the light output end directly. Use appropriate laser safety eye-wear(i.e. laser goggles) when operating the device.

Safety labels and locations



Figure 1 Warning Signs

The two labels above in Figure 1 are located on the top of the cover of the device, representing laser radicalization.

Content

1. Description.....	1
1.1. Product description.....	1
1.2. Actual configuration list.....	1
1.3. Environmental requirements and cautions	1
1.4. Specifications	2
2. Mounting	4
2.1. Mounting dimensions	4
2.2. Method of installation	4
3. Control Interface	6
4. Operation Regulations.....	12
4.1. Pre-inspection.....	12
4.2. Operation procedures	12
4.3. Cautions.....	12
5. Instructions for warranty, return and maintenance.....	13
5.1. General warranty	13
5.2. Limitations of warranty	13
5.3. Service and repairs	13

1. Description

1.1. Product description

Raycus pulsed lasers are specially developed for high-speed and efficient laser marking systems. For industrial laser marking machine and other applications provide an ideal high-power laser energy source.

Compared with traditional laser, pulsed laser can increase the conversion efficiency of pump light per watt by more than 10 times. Automatic design for high-volume consumption, suitable for laboratory or outdoor operation, compact, can be placed independent, can be used at any time, can be directly embedded on the user's device.

The device can emit 1060~1085nm wavelength pulsed light under the control of industrial laser's standard interface driven by 24V DC power source.

1.2. Actual configuration list

Please refer to the included list according to Table 1.

Table 1 Configuration list

Items	Quantity
Fiber Laser module	1
Factory inspection report	1

1.3. Environmental requirements and cautions

Pulsed laser should be driven by 24V DC \pm 1V power source.

- a) Caution: Make sure the corresponding wires of the device are properly grounded.
- b) All the maintenance to the device should only be done by Raycus, because there is no replacement or accessory provided with the device. Please do not try to damage the labels or open the cover in order to prevent against electric shock, or the warranty will be invalid.
- c) The output head of the product is connected with an optical cable. Please be careful handling the output head. Avoid dirt and any other contamination. Please use the specialized lens paper when cleaning the lens. Please lid the laser with protective cover of the light isolator to be against dirt only when the laser is not installed in the device or not in working.
- d) If the operating the device fails to follow this instruction, the protective function will be weakened. Therefore, it should be used under normal conditions.
- e) Do not install the collimating device into the output head when the laser device is in working.

- f) The device has four cooling fans at the rear panel to dissipate heat. In order to guarantee enough airflow to help giving heat off, there must be a space of at least 10 cm's width for airflow in front and rear side of the device. As the cooling fans are working at blow condition, if laser is mounted in a cabinet with fans, the direction should be same as laser's fans.
- g) Do not look into the output head of the device directly. Please do wear appropriate laser safety eyewear during operation of the device.
- h) The longest time without pulse is only 100 μ s . If there is no pulse output, please stop marking at once to avoid the further damage of the device.
- i) Power source sudden interruption will do great harm to the laser device. Please make sure the power supply works continuously.

1.4. Specifications

Table 2 P70MX pulsed fiber laser specifications

NO.	Characteristic	Test condition	Min	Typ.	Max.	Unit
1	Mode of operation		Pulsed			
2	Polarization		Random			
3	Maximum pulse energy	350ns/46kHz/70W	1.5			mJ
4	Nominal average output power		70	73	75	W
5	Pulse duration	Subject to Table 3	10	/	350	ns
6	Output power adjustment range		0	/	100	%
7	Long-term average power instability				5	%
8	Pulse repetition rate	Subject to Table 3	1	/	2000	kHz
9	Central emission wavelength	FWHM	1059	1064	1069	nm
10	Emission bandwidth	FWHM	3	8	10	nm
11	Beam quality M ²	350ns/46kHz/70W	1.3	/	1.6	
12	Output beam diameter	350ns/46kHz/70W	6	7	8	mm
13	Laser switching ON time	0-100% power	0	/	100	μ s
14	Laser switching OFF time	100-10% power	0	3	30	μ s
15	Output fiber cable length		/	3	/	m
16	Supply voltage		23	24	25	VDC
17	Guide Laser Power		0.2	0.5	1	mW
18	Anti Strong Back Reflection		Yes			
19	Cooling		Forced Air Cooled			
20	Operating Temperature		0	/	40	$^{\circ}$ C

Table 2 (continued)

21	Storage Temperature		-20	/	60	°C
22	Humidity		/	/	80	%
23	Power Consumption		/	/	450	W
24	Laser module dimensions	W×D×H	350×320×120			mm

Table 3 Pulse repetition rate PRR and maximum pulse energy $E_{Pules,max}$ for different pulse duration τ

NO.	τ [ns]	PRR_{min} [kHz]	P_{PRRmin} [W]	PRR_0 [kHz]	P_{PRR0} [W]	PRR_{max} [kHz]	P_{max} [W]
1	10	1	0.1-4W	700	70-75W	2000	70-75W
2	20	1	0.2-4W	350	70-75W	2000	70-75W
3	30	1	0.3-4W	231	70-75W	1000	70-75W
4	60	1	0.5-4W	140	70-75W	1000	70-75W
5	100	1	0.8-4W	88	70-75W	1000	70-75W
6	200	1	1.25-4W	56	70-75W	500	70-75W
7	250	1	1.4-4W	51	70-75W	500	70-75W
8	350	1	1.5-4W	46	70-75W	400	70-75W
9	CW	100	1.5-4W	/	70-75W	500	70-75W

2. Mounting

2.1. Mounting dimensions

a) Dimension drawing

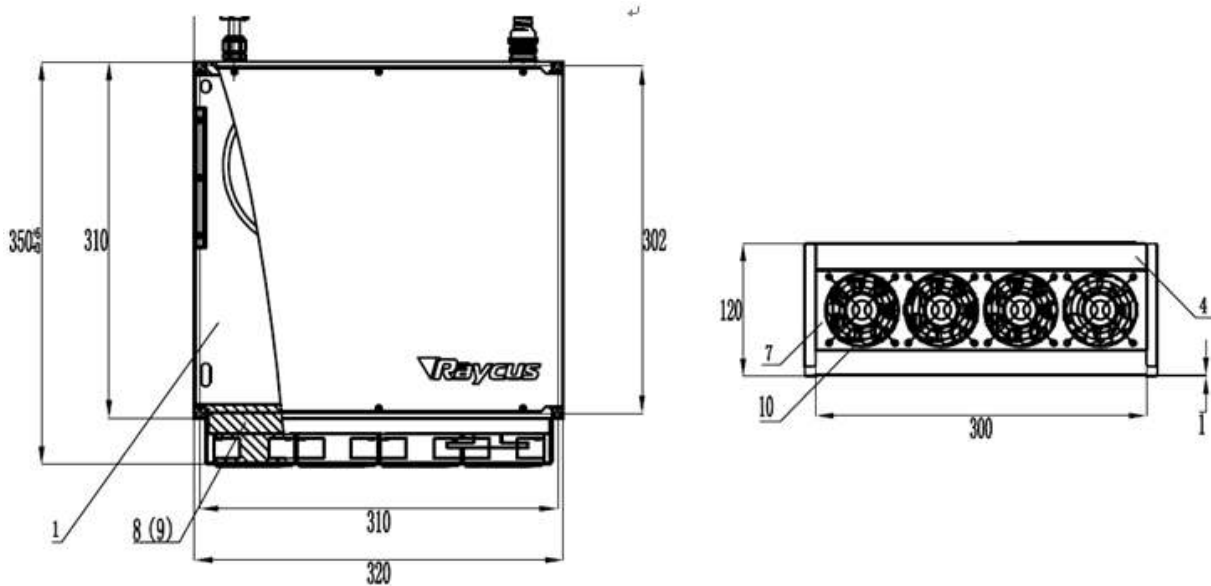

Figure 2 Dimension drawing of laser module (Unit: mm).

b) Dimension drawing of output isolator

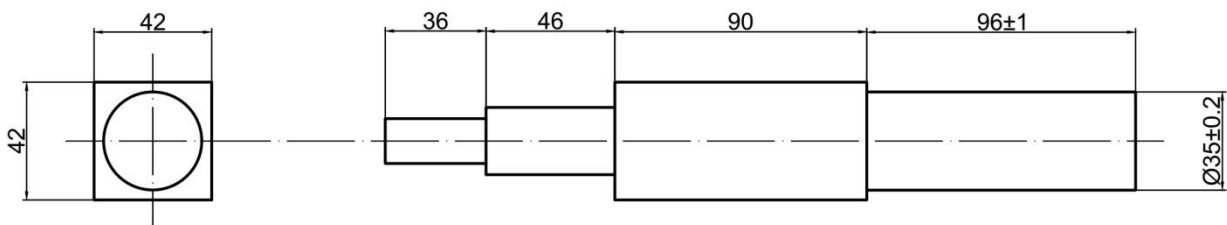

Figure 3 Dimension drawing of output isolator (Unit: mm).

*The output head of the isolator is subject to the final factory product.

2.2. Method of installation

- Fix the module stable to the bracket and keep the laser in good ventilation.
- Connect the power line to 24V DC power and ensure enough DC output power. Keep it clear to the polarity of the electric current: Anode-brown, Cathode-blue, PE-yellow and green.



Figure 4 Definition of power line wires

- c) Make sure that the interface of the external controller matches the laser and the control cable is well connected to the laser's interface. The recommended electrical connection is shown in Figure 4.

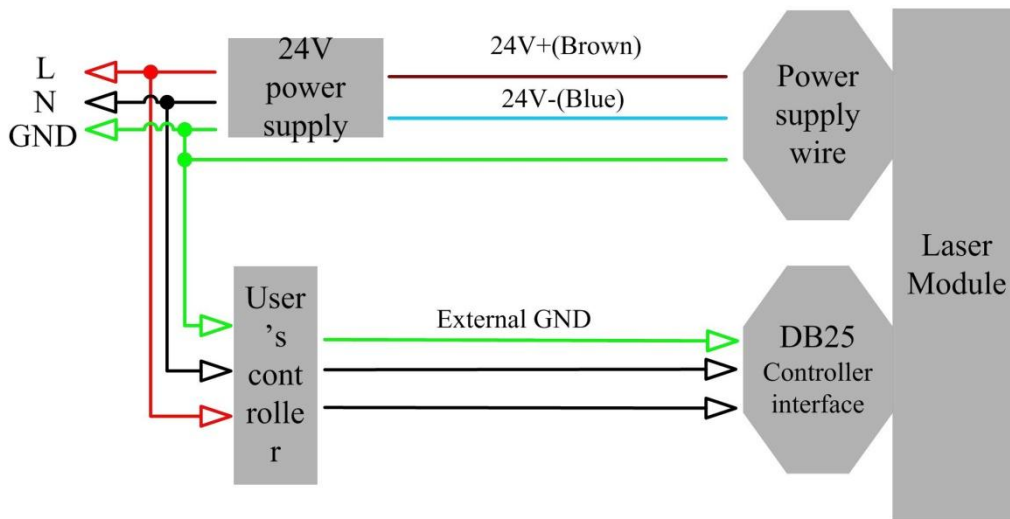

Figure 5 Wiring diagram of recommended electrical connection and power supply

- d) The bending radius of the delivery fiber should not exceed 15 cm.

3. Control Interface

There are DB9 and DB25 interfaces at the rear of the laser. The DB9 is a RS232 interface only used for debugging, no needs to connect. And DB25 is the joint interface connecting control system to the laser system, please make sure the connection is reliable before operation. Feet of the DB25 are defined as follows in Table 4.

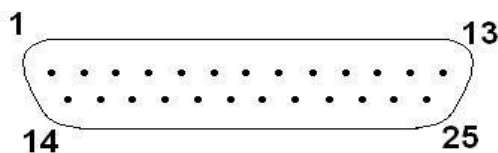

Figure 6 Pin definition of DB25 control interface

Table 4 Definition of connect ports of controller

Pin No.	Name	Description
1-8 (D0-D7)	Power Setting	8 bit Parallel port; D0 is minimum bit and D7 is maximum bit; Range: 0-255 (hexadecimal: 0X00-0XFF).
10,14	Ground	Digital GND.
11,12,16,21	Laser alarms status	see alarm codes in Table 5.
17	VCC	+5VDC power supply input. Providing power for inside isolate chip of DB25 to ensure that the input and output signal are valid.
18	EE	Emission Enable (EE) signal. HIGH(>4.5V): Emission Enable LOW or disconnected (<1V): Emission Disable
19	EM	Emission Modulation (EM) input. HIGH (>4.5V): Emission ON LOW or disconnected (<1V): Emission OFF
20	Sync	Pulse Repetition Rate (Synchronization) input, square wave.
23	Emergency Off	Emergency Switch Off(Enable: 5V TTL)
9	Obligate Pin	Reserved

- a) The pump current of the diode laser and the laser output power are controlled by setting the value of Pin1-Pin8 (TTL level). Pin1-Pin8 can be set from 0 to 255, corresponding to the laser output power from 0 to 100% (the actual laser power may not be strictly linear with the setting value). The relationship between Pin value and output power is shown in Table 5.
- b) Pin 10 and Pin 14 are all digital GND.

Table 5 Definition of power control Pins.

	Setting 1	Setting 2	Setting 3	Setting 4	Setting 5
Pin 1	0	0	0	0	1
Pin 2	0	0	0	0	1
Pin 3	0	0	0	0	1
Pin 4	0	0	0	0	1
Pin 5	0	0	0	1	1
Pin 6	0	0	1	1	1
Pin 7	0	1	1	1	1
Pin 8	1	1	1	1	1
Current	~50 %	~75 %	~87.5 %	~93.75 %	100%

- c) Pin 17 receives external 5V DC voltage to provide power supply for inside isolate chip of DB25, thus the input and output signals are valid.
- d) Pin 18 is the start signal of the MO. Pin19 is the input for the optical output signal. The electrical level for both Pin18 and Pin19 are 5V. Before turning on Pin 19, MO signal must be switched ON, in other word, the signal of Pin 18 must be ahead of Pin 19 at least 5 ms, and otherwise the laser machine may be damaged.
- e) Pin 20 provides control of the frequency. The frequency range should be 1kHz~2000 kHz, depends on the varying power levels of different laser machines.
ATTENTION: The frequency signal must be ahead of the EM signal at least 5 ms, otherwise the laser machine may be damaged.
- f) Below figure shows DB25 sequence diagram:

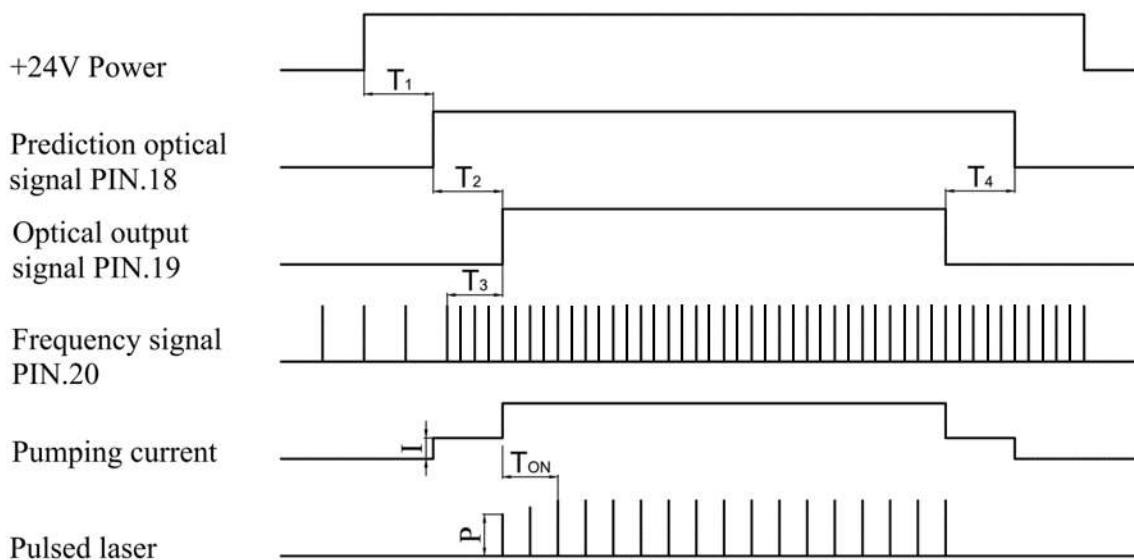

Figure 7 DB25 sequence diagram

- 1) T_1 represent the initialization time of the laser machine. The initialization time is less than 10s from power-on to perform initialization.
- 2) T_2 represent the pump recharge time, usually around 5ms.
- 3) T_3 represent the frequency switching time. Frequency needs to be adjusted before optical laser output, and the switching time should not less than 5ms.
- 4) T_4 2-8ms with external frequent mode, recommend 4ms.
- 5) T_{ON} represents the pulse build-up time. Usually the build-up time is less than 50 us from the pump current raising up to reach the 90% power of the optical pulse.
- 6) I is the simmer pump current.
- 7) P means the height of the first pulse is adjusted by the pre-injection current I and the reasonable height of the first pulse have been set before the laser leaves the factory, which can meet the needs of most users. Special needs shall be put forward in the customized contract.

g) Definition of alarm signal

Table 6 Definition of alarm signal

Pin12	Pin11	Pin16	Pin21	Alarm content
×	Low	Low	Low	Laser TemperatureAlarm ¹
×	Low	Low	High	Normal
×	High	Low	Low	System Error ²
×	Low	High	High	Power Error ³

- 1) PS¹: Pin 17 receives external DC voltage to provide power supply for inside isolate chip of DB25. Therefore, please make sure Pin17 is connected to the +5V power supply. The temperature warning will remain if the power or DB25 port is not well connected.
 - 2) PS²: If the voltage or current states of the laser are abnormal, the alarm might present “POWER ERR” due to using different marking card (for example: Beijing JCZ Technology Co. marking card).
 - 3) PS³: If the laser output system is abnormal, the alarm might present “SYSTEM ERR” due to using different marking card (for example: Beijing JCZ Technology Co. marking card).
- h) Inside interface circuit of input and output signal from DB25:

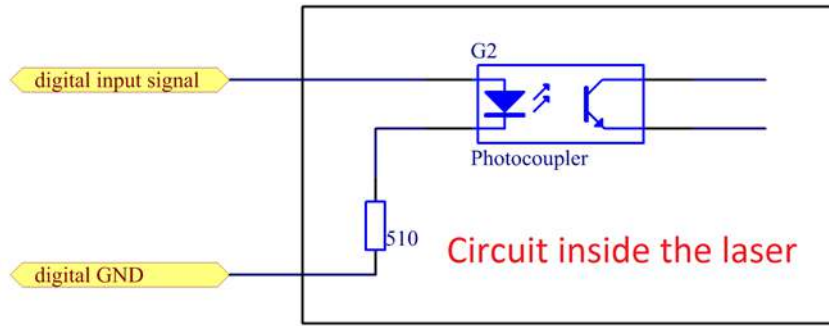

Figure 8: Interface circuit of input signal

Signal input needs to be able to provide at least 7 mA of current. Interface circuit of output signal from DB25 is shown in Fig. 9.

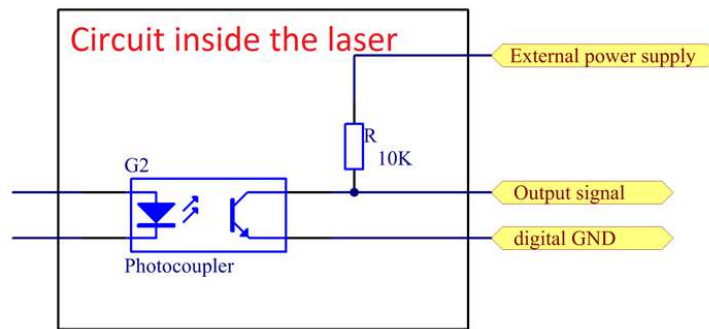

Figure 9: Interface circuit of output signal

i) Introduction of laser pulse duration control

Pin2, 3, 16 and 22 on DB25 port not only used for the foundation control of the laser machine, but also achieves the pulse duration control as the extender.

Table 7 PIN Definition of Serial Communication

Pin	Name	Description
2	Serial input	The setting of the data bits synchronize with rising edge of the serial clock.
3	Serial clock	Serial clock, frequency range: 10KHz~100KHz.
14	GND	Digital GND
16	SO	The output data bits synchronize with rising edge of the serial clock.
22	Pulse duration control Enable	High: Enable, Pin2 and Pin3 control the pulse duration; Low or disconnected: Disable

Table 8 Command format of setting the laser pulse duration

Frame (1byte)	Command word (1 byte)1	Pulse duration(2byte)ns
0xA5	0x01	Big Endian

Table 9 Response format of setting the laser pulse duration

Frame (1byte)	Pulse duration(2byte)ns
0xA5	Big Endian

- 1) Marking machine sends the command to the laser machine by the Pin2 on the DB25 port, meanwhile sends the clock signal to the Pin3. The comment is the binary form, and delivers the most significant bit as the priority.
- 2) The order structure from marking machine to the laser machine is: 0xA5+instruction code.
- 3) 0xA5 (A5h) is the comment byte to active the laser pulse duration control port. 0xA5 and the following data will be directly sent as the serial input form to the Pin2 on the DB25 port.
- 4) The input data length is 4 bytes: the first byte of instruction code should be 0x01 (01h) ,the second byte and the third byte are the value of the binary coding of laser duration (for example: 200 is the decimal number of 0x00C8, represents the setting pulse duration is 200ns).
- 5) Pin22 is the Enable signal. The Enable should achieve high state at least 10us before Pin2 and Pin3 changing. The Enable should achieve low state at least 10us after Pin2 and Pin3 changing. Figure 14 shows the adjustment process of laser duration control.
- 6) Pin19 should decrease to low state before adjusting laser pulse duration.
- 7) Optional pulse width :10\20\30\60\100\200\250\350ns.

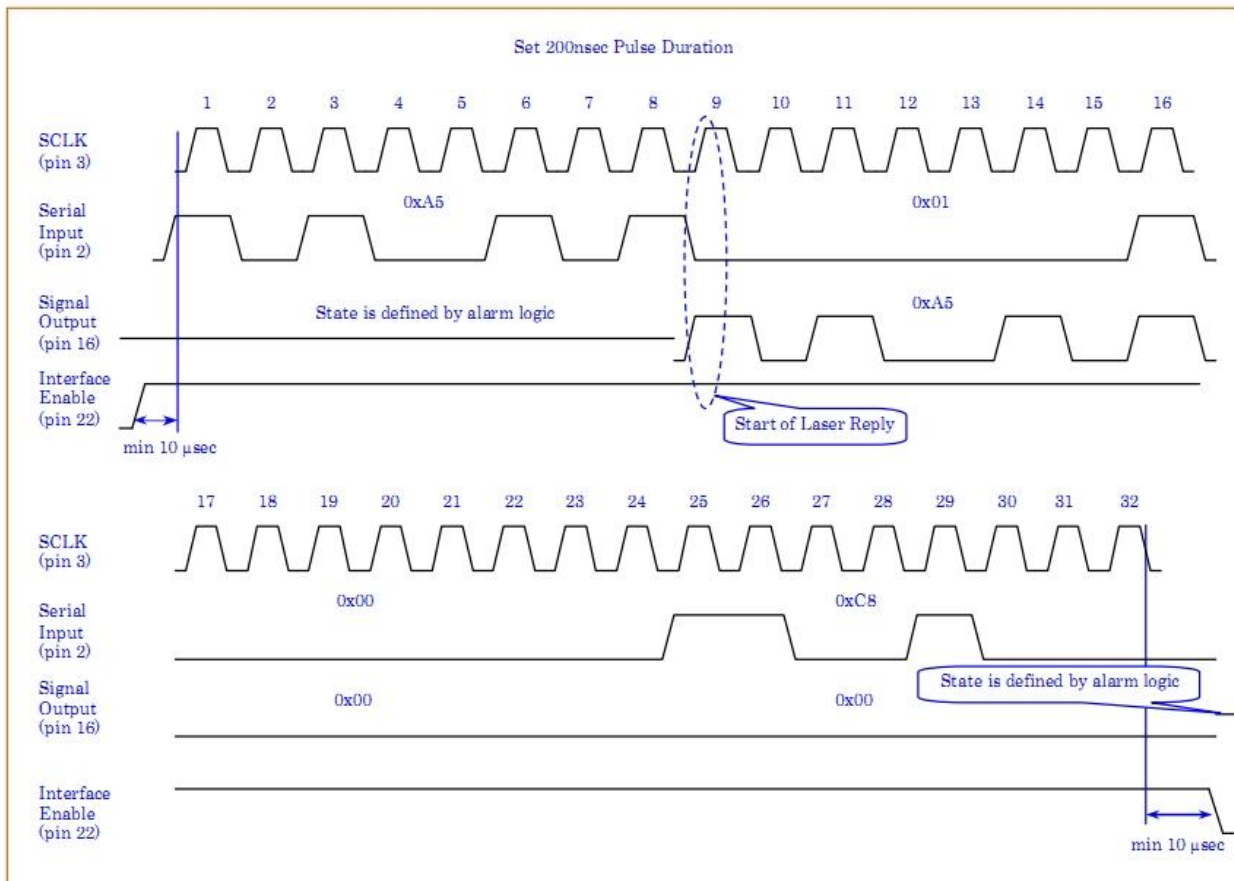

Figure 10. Schematic of laser pulse duration adjustment (200ns)

For example, if using Beijing JCZ Technology Co. marking card to adjust laser pulse duration, the setting processes are described as follows:

- a) Make sure the power supply, DB25 cable, control card and computer are correctly connected, and then turn on the 24V power supply.
- b) Open Ezcad2.7.6 (or other versions), then click 'F3', the configuration parameter should show up, select 'Fiber' in the category of the 'Laser Control' panel, follow that select 'IPG_YLPM', and then close this window.
- c) Pulse duration can be modified by the 'Duration' on the right side of the window. If the setting duration is smaller than the limiting minimum value, the duration of output laser will be 2ns (minimum). If the setting duration is larger than the limiting maximum value, the duration of output laser will be continuous work (maximum). If the setting duration within the range, the duration of output laser will tend to the smaller side.

4. Operation Regulations

4.1. Pre-inspection

- a) Make sure the device appearance is in good condition and the output fiber is neither excessively bended nor broken.
- b) Make sure signal line of laser and marking system are properly connected.

4.2. Operation procedures

a) Starting procedures

Please make sure the control system is on before you turn on the fiber laser. Only after at least 1 minute since the power turned on, the subsequent operations can be proceeded.

b) Frequency set introductions

The frequency setting range is from 1 kHz to 2000 kHz(The actual frequency range of each pulse width is showed in the Table 3).

c) Laser marking checking

For the device initial testing, first turn the power down to zero without turning on the marking system after the device is successfully started. Then draw a quadrate, marking continuously while slowly increasing the power from 1% to 100% at the same time. Meanwhile, use a ceramic material to observe the laser and the laser should become stronger, otherwise shut down the device and check.

If operating normally, the marking system can be used in common order afterwards.

4.3. Cautions

- a) Marking frequency must be in the range of 1 kHz to 2000 kHz(The actual frequency range of each pulse width is showed in the Table 3).
- b) It should not modify the frequency while marking.
- c) Stop marking first before shutting down the device, then turn the power down to zero and cut the power off.

5. Instructions for warranty, return and maintenance

5.1. General warranty

All products are warranted by Raycus against defects and problems in materials and workmanship during the warranty period according to the purchase order or specifications and we guarantee the product will accord with the specification under normal use.

Raycus has the right to choose to repair or replace any product that proves to be defective in materials and workmanship selectively during the warranty period. Only products with particular defects are under warranty. Raycus reserves the right to issue a credit note for any defective products which are produced in normal conditions.

5.2. Limitations of warranty

The warranty does not cover the maintenance or reimbursement of our product of which the problem results from tampering, disassembling, misuse, accident, modification, unsuitable physical or operating environment, improper maintenance, damages due to excessive use or not following the instructions caused by those who are not from Raycus. Customer has the responsibility to understand and follow this instruction to use the device. Any damage caused by fault operating is not warranted. Accessories and fiber connectors are excluded in this warranty.

According to the warranty, client should write to us within 31days since the defect is discovered. This warranty does not involve any other party, including specified buyer, end-user or customer and any parts, equipment or other products produced by other companies.

5.3. Service and repairs

Raycus is responsible for all the maintenance, for there is no accessory available inside for users to use. Please contact Raycus as soon as possible when problems under warranty about maintenance happen to the product. The product returned with permission should be placed in a suitable container. If any damage happens to the product, please notify the carrier in document immediately.

All the items about warranty and service above provided by Raycus are only for reference; formal contents about warranty and service are subject to the contract.